

# General Specifications

## Model JA12 Distributor (2-output Type) (with Square Root Extractor)

JUXTA

GS 77J03A01-02E

### General

The JA12 is a plug-in type distributor that is used in combination with a two-wire type transmitter to convert the transmitter's 4 to 20 mA DC signals into isolated DC current or DC voltage signals.

- Selection of square root extractor, I/O adjustment, I/O monitoring, and segmental point setting (for custom order only) can be made through a PC (VJ77) or Handy Terminal (JHT200).
- The operation indicating lamp shows the operating status, abnormal setting and the like.
- I/O adjustment can be made using a switch on the front of the JA12 without a setting tool such as Handy Terminal.

### Model and Suffix Codes

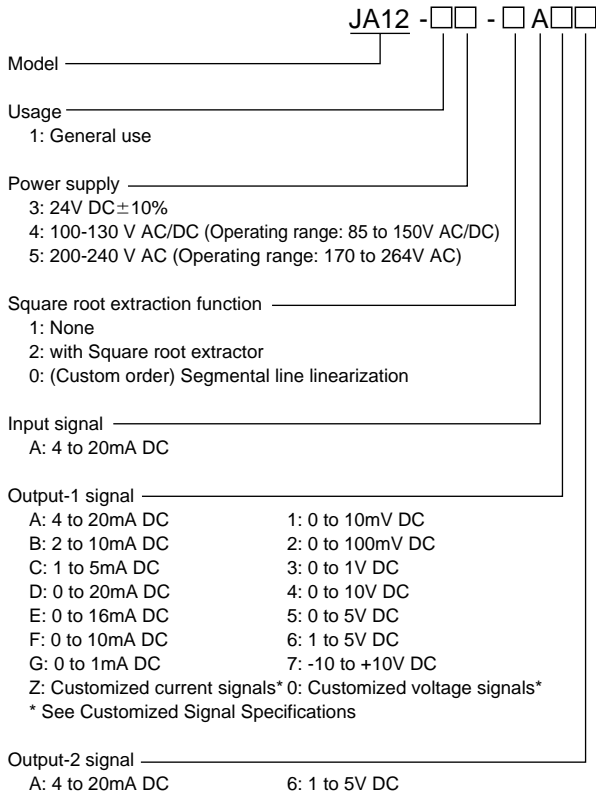

### Items to be Specified when Ordering

- Model and Suffix Codes: e.g. JA12-14-2AA6  
Specify a lowcut point when "with square root extractor" is required: e.g. Lowcut point 0.4%  
The distributor will be shipped with a lowcut point of 0.6% if no specification of lowcut point.

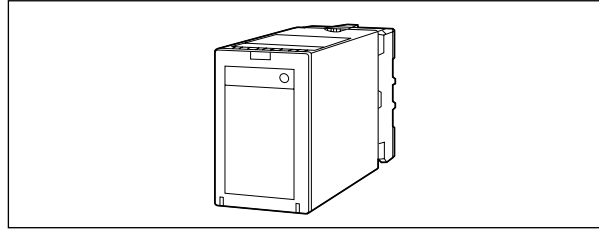

Specify segmental points (32 points) in Work Sheet when segmental line linearization is required. The distributor will be shipped with proportional I/O if no specification of segmental points.

### Input/Output Specifications

Input signal: 4 to 20 mA DC signal from two-wire type transmitter

Input resistance: 250 Ω

Transmitter power supply: 25.25 ± 0.25 V DC (provided with a current limiter to keep the current between 25 and 35 mA)

Allowable conductor resistance (RL): Up to [(20 – transmitter's minimum operating voltage) V / 0.02 A] Ω

Maximum allowable input current: 40 mA DC

Square Root Extraction Function: Outputted against the result of extracting square root of input.

$$Y = \left( \sqrt{\frac{X - (\text{input } 0\% \text{ value})}{\text{input span}}} \right) \times (\text{output span}) + (\text{output } 0\% \text{ value})$$

Lowcut Function: Available only when the square root extraction function is specified.

Setting Range: 0.3 to 100 % of input, setting available by 0.1 % notch

Output for lowcut point or less is cramped with straight line proportional to input.

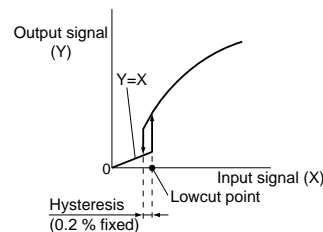

Output signal: DC voltage or DC current signal  
 Allowable load resistance:

Output-1 Range	Allowable Load Resistance	Output-1 Range	Allowable Load Resistance
4 to 20 mA DC	750 Ω maximum	0 to 10 mV DC	250 kΩ minimum
2 to 10 mA DC	1500 Ω maximum	0 to 100 mV DC	250 kΩ minimum
1 to 5 mA DC	3000 Ω maximum	0 to 1 V DC	2 kΩ minimum
0 to 20 mA DC	750 Ω maximum	0 to 10 V DC	10 kΩ minimum
0 to 16 mA DC	900 Ω maximum	0 to 5 V DC	2 kΩ minimum
0 to 10 mA DC	1500 Ω maximum	1 to 5 V DC	2 kΩ minimum
0 to 1 mA DC	15k Ω maximum	-10 to +10 V DC	10 kΩ minimum
Output-2 Range	Allowable Load Resistance	Output-2 Range	Allowable Load Resistance
4 to 20 mA DC	350 Ω maximum	1 to 5 V DC	2 kΩ minimum

Input adjustment: ±1% of span minimum (Zero/Span)  
 Output adjustment: ±5% of span minimum (Zero/Span)

### Standard Performance

Accuracy rating: ±0.1% of span

Accuracy is not guaranteed for output levels less than 0.1mA for the output codes D, E, and F, and for output levels less than 0.0125mA for the output code G. ±1% of span for the input from 1% to 2% when using square root extractor

Response speed: 200 ms, 63% response (10 to 90%)

Insulation resistance: 100 MΩ minimum at 500 V DC between input, output-1, output-2, power supply and grounding terminals mutually

Withstanding voltage: 2000 V AC for one minute between input, (output-1, output-2), power supply and grounding terminals mutually  
 1000 V AC for one minute between output-1, output-2 terminals mutually

Operating temperature range: 0 to 50°C

Operating humidity range: 5 to 90% RH (no condensation)

Supply voltage range: 24 V DC ±10%  
 100 to 130 V AC/DC (±15%)  
 200-240 V AC (-15%, +10%)

Effects of power line regulation: Up to ±0.1% of span for the regulation within allowable range of each supply voltage range

Effects of ambient temperature variations: Up to ±0.2% of span per 10°C

Power consumption:

3.9 W at 24 V DC; 3.7 W at 110 V DC;  
 7.1 VA at 100 V AC; 9.3 VA at 200 V AC

### Mounting and Appearance

Material: Case body; ABS resin (black), UL94 V-0  
 Socket; Modified polyphenylene oxide, including glass fiber (black), UL94 V-1

Mounting method: Wall or DIN rail mounting  
 More than 5 mm interval is required for side-by-side close mounting.

Connection method: M3.5 screw terminals

External dimensions: 86.5 (H)×51 (W)×133 (D) mm (including a socket)

Weight: Approx. 200 g (main unit), approx. 80 g (socket)

### Accessories

Spacer: One (used for DIN rail mounting)  
 Range labels: Two

### Customized Signal Specifications

#### Customized output

	Current Signal	Voltage Signal
Output range (DC)	0 to 20 mA	-10 to +10 V
Span (DC)	1 to 20 mA	10mV to 20 V
Zero elevation	0 to 150 %	-125 to +400 %

\* -50 to +25% for the span of 20 mV DC or less.

#### Customized segmental line linearization

Segmental points: 32 (Set I/O relation by percentage)  
 Settable range of segmental points: -6 to +106% for both of input and output

### Front Panel

I/O adjustment is available using selection switch and adjustment switch.

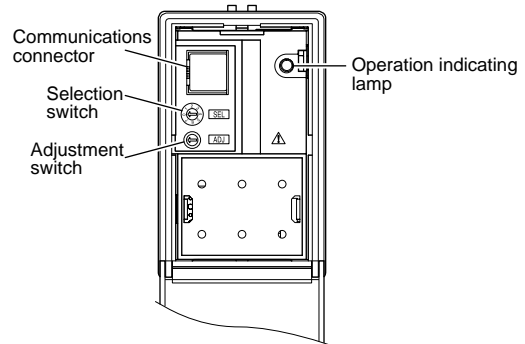

The position of a selection switch	Adjustment item
0	No function
1	Output-1 zero adjustment
2	Output-1 span adjustment
3	Output-2 zero adjustment
4	Output-2 span adjustment
5	Input zero adjustment
6	Input span adjustment

### Terminal Assignments

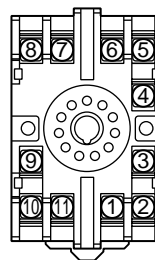

1	OUTPUT-1	(+)
2	OUTPUT-1	(-)
3	N.C.	
4	INPUT	(PS+)
5	INPUT	(-)
6	INPUT	(COM)
7	SUPPLY	(L+)
8	SUPPLY	(N-)
9	GND	
10	OUTPUT-2	(+)
11	OUTPUT-2	(-)

## Block Diagrams

(1) Combination with two-wire type transmitter using internal power supply

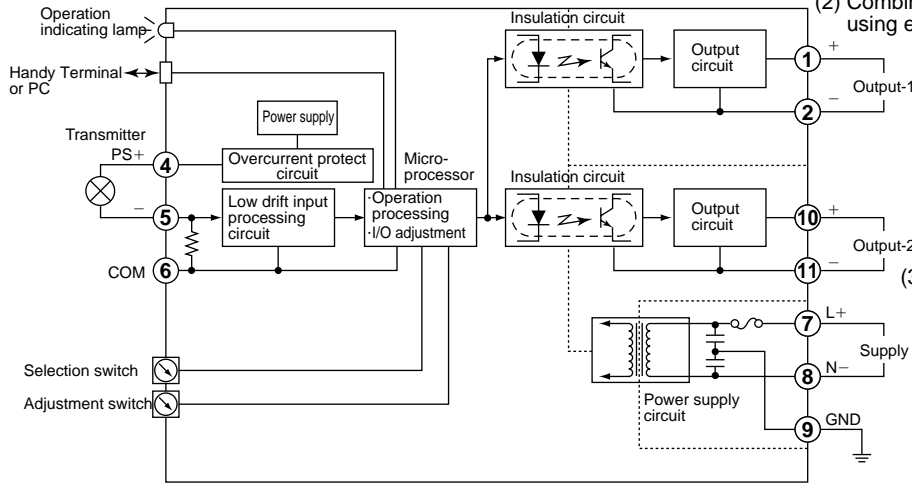

(2) Combination with two-wire type transmitter using external power supply

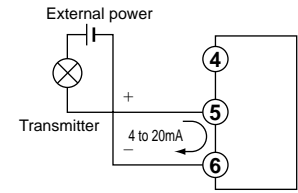

(3) Example to construct Intrinsically Safe System using Zener Barrier

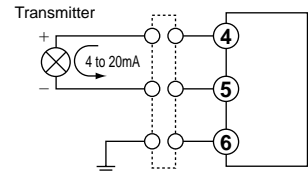

## External Dimensions

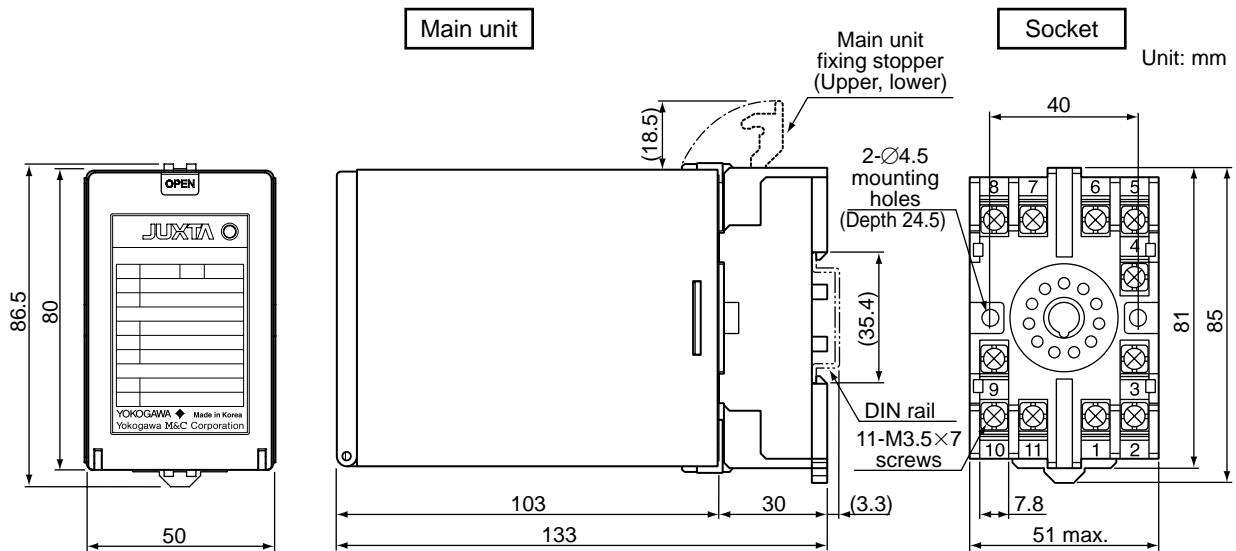

<Mounting Dimensions>

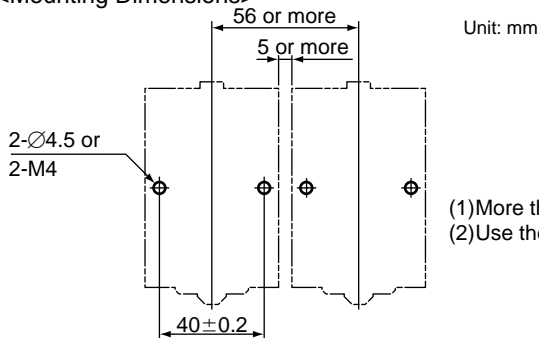

- (1) More than 5 mm interval is required for side-by-side close mounting.
- (2) Use the supplied spacer for DIN rail mounting to keep 5 mm interval.

**Work Sheet**

Model and Suffix Codes

Write at least 2 points for input and output segmental points data.

Input (%)				Output (%)				Input (%)				Output (%)			
X0				Y0				X16				Y16			
X1				Y1				X17				Y17			
X2				Y2				X18				Y18			
X3				Y3				X19				Y19			
X4				Y4				X20				Y20			
X5				Y5				X21				Y21			
X6				Y6				X22				Y22			
X7				Y7				X23				Y23			
X8				Y8				X24				Y24			
X9				Y9				X25				Y25			
X10				Y10				X26				Y26			
X11				Y11				X27				Y27			
X12				Y12				X28				Y28			
X13				Y13				X29				Y29			
X14				Y14				X30				Y30			
X15				Y15				X31				Y31			

(Specification conditions)

Input conditions:  $-6.0\% \leq X_0 < X_1 < X_2 < \dots < X_{n-1} < X_n \leq 106.0\%$

Output conditions:  $-6.0\% \leq (Y_0 \text{ to } Y_n) \leq 106.0\%$

• The information covered in this document is subject to change without notice for reasons of improvements in quality and/or performance.